

## Features

- Transceiver unit with independent
  - ✦ 1550nm DFB Laser diode transmitter
  - ✦ InGaAs PIN photodiode receiver
- Meet SFF MSA and SFF-8472 with duplex LC receptacle
- Digital diagnostic monitoring
- Hot-pluggable
- Metal enclosure for lower EMI
- +3.3V Single power supply
- Qualified to meet the intent of Bellcore reliability practices
- LVPECL logic interface simplifies interface to external circuitry
- LVTTTL logic Signal level RX LOS
- With pull de-latch
- Links of 60km with 9/125  $\mu\text{m}$  single mode fiber (SMF)

## Application

- ATM
- SONET
- Ethernet
- Switches
- Routers
- Hubs
- Fiber Channal

## General

The optical transceiver is compliant with the Small Form- Factor Pluggable (SFP) Multi-Source Agreement (MSA) and SFF-8472. It offers previously unavailable system cost, upgrade, and reliability benefits by virtue of being hot-pluggable.

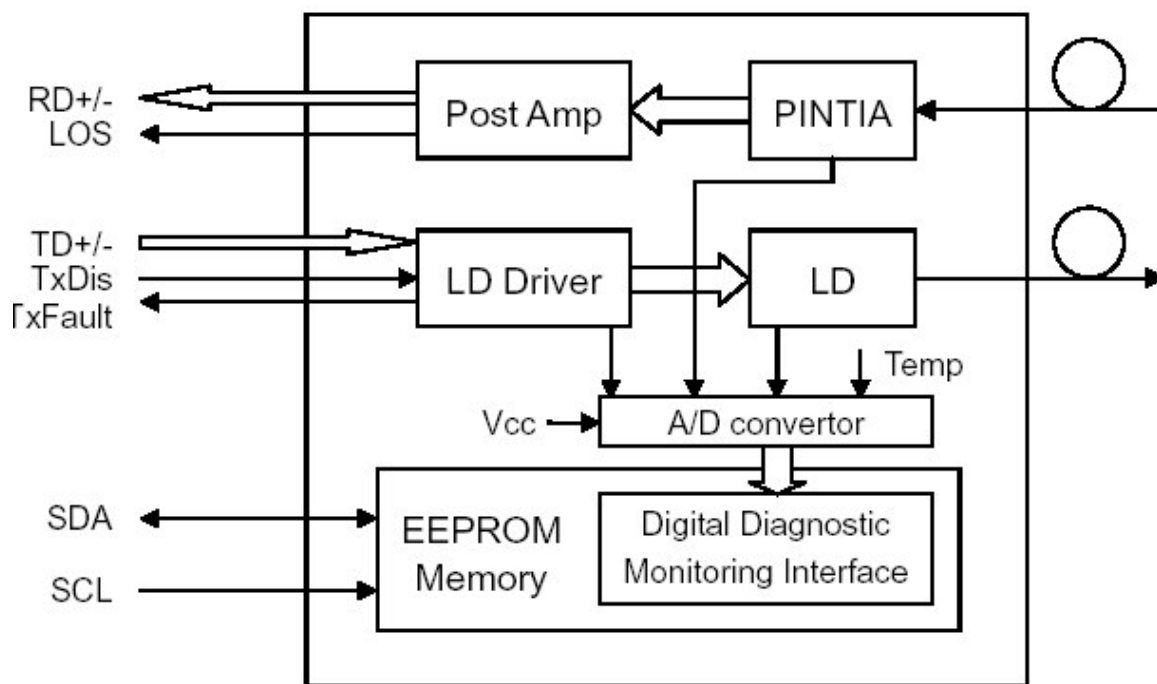

### Transmitter Section

Transmitter is designed for single mode fiber and operates at a nominal wavelength of 1550nm. The transmitter module uses a DFB laser diode and full IEC825 and CDRH class 1 eye safety. The output power can be disabled via the single TxDis pin. Logic LVTTTL HIGH level disables the transmitter. It contains APC function, temperature compensation circuit, PECL data inputs, LVTTTL Txdis input and Tx fault Output interface.

### Receiver Section

The receiver section uses a hermetic packaged front end receiver (InGaAs PIN and preamplifier). The postamplifier is ac coupled to preamplifier through a capacitor and a low pass filter. The capacitor and LPF are enough to pass the signal from 5Mb/s to 200Mb/s without significant distortion or performance penalty. The LPF limits the preamplifier bandwidth to improve receiver sensitivity. As the input optical is decreased, LOS will switch from low to high. As the input optical power is increased from very low levels, LOS will switch back from high to low.

### EEPROM Section

The optical transceiver contains an EEPROM. It provides access to sophisticated identification information that describes the transceiver's capabilities, standard interfaces, manufacturer, and other information.

The serial interface uses the 2-wire serial CMOS EEPROM protocol defined for the ATMEL AT24C01A/02/04 family of components. When the serial protocol is activated, the host generates the serial clock signal (SCL, Mod Def 1). The positive edge clocks data into those segments of the EEPROM that are not write protected within the SFP transceiver. The negative edge clocks data from the SFP transceiver. The serial data signal (SDA, Mod Def 2) is bi-directional for serial data transfer. The host uses SDA in conjunction with SCL to mark the start and end of serial protocol activation. The memories are organized as a series of 8-bit data words that can be addressed individually or sequentially. The Module provides diagnostic information about the present operating conditions. The transceiver generates this diagnostic data by digitization of internal analog signals. Calibration and alarm/warning threshold data is written during device manufacture. Received power monitoring, transmitted power

monitoring, bias current monitoring, supply voltage monitoring and temperature monitoring all are implemented. The diagnostic data are raw A/D values and must be converted to real world units using calibration constants stored in EEPROM locations 56 – 95 at wire serial bus address A2h. The digital diagnostic memory map specific data field define as following.

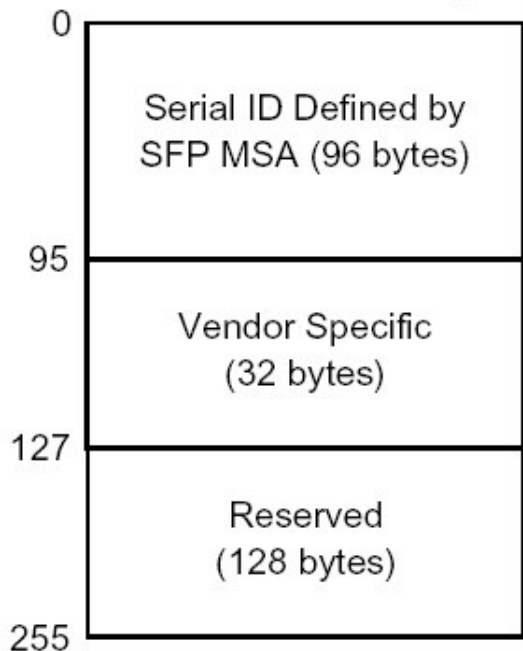

**2 wire address 1010000x (A0h)**

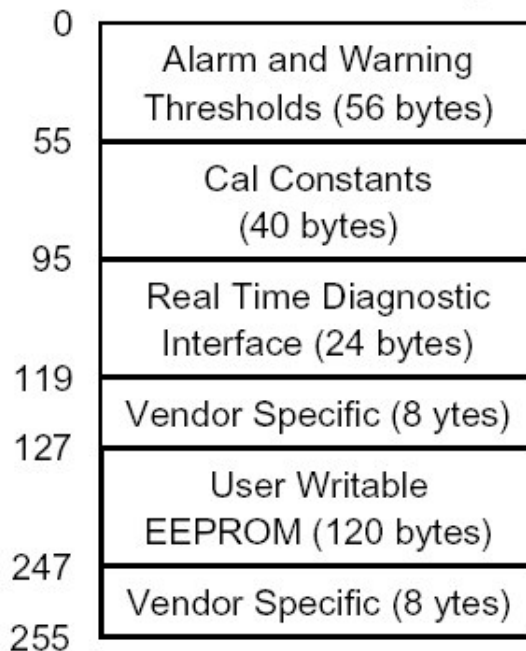

**2 wire address 1010001x (A2h)**

**Performance Specifications**

**Table1. Absolute Maximum Ratings**

Parameter	Symbol	Min	Max	Unit	
Storage Temperature	Tst	-40	+85	°C	
Operating Temperature	To	SSFP5251-23-125	0	70	°C
		SSFP5251-23-225	-40	+85	
Input Voltage	-	GND	Vcc	V	
Power Supply Voltage	Vcc-Vee	-0.5	+3.6	V	

**Note: Stress in excess of maximum absolute ratings can cause permanent damage to the module**

**Tabel 2. Operating Environment**

Parameter	Symbol	Min	Max	Unit	
Power Supply Voltage	Vcc	+3.1	+3.5	V	
Operating Temperature	Tc	SSFP5251-23-125	0	+70	°C
		SSFP5251-23-225	-40	+85	

**Table 3. Transmitter electrical and optical Characteristics**

Parameter	Symbol	Min	Typ	Max	Unit	Note
Center Wavelength	$\lambda_p$	1480	1550	1580	nm	-
Spectral Width	$\Delta\lambda$	-	-	1.0	nm	-
Side Mode Suppression Ratio	SMSR	30	-	-	dB	
Average Optical Output Power	Po	-3	-	+2	dBm	-
Extinction Ratio	EXT	8.2	-	-	dB	-
Transmitter disable Voltage	V <sub>D</sub>	2.0	-	V <sub>cc</sub>	V	-
Transmitter Enable Voltage	V <sub>EN</sub>	0	-	0.8	V	-
Power supply Current	I <sub>cc</sub>	-	70	180	mA	1
Data Input Voltage	V <sub>pp</sub>	300	-	1600	mV	-
Optical Rise/Fall Time	Tr/TF	-	-	0.26	ns	-

**Table 4.Receiver optical-electrical characteristics**

Parameter	Symbol	Min	Typ	Max	Unit	Note
Operate Wavelength	-	1260	-	1580	nm	-
Sensitivity	Pr	-	-25	-22	dBm	2
Saturation	Ps	-3	-	-	dBm	2
LOS Asserted	-	-40	-	-	dBm	Low Level: Alarm
LOS De-Assert	-	-	-	-22	dBm	
LOS Hysteresis	-	-	1.5	-	dB	
LOS LOW voltage	V <sub>Lout</sub>	-	-	0.8	V	-
LOS HIGH voltage	V <sub>Hout</sub>	2.0	-	-	V	-
Power Supply Current	I <sub>cc</sub>	-	80	170	mA	1
Data Outputs Voltage	V <sub>pp</sub>	400	800	1000	mV	-

**Notes:**

1. The current excludes the output load current.
2. Minimum Sensitivity and saturation levels for a  $2^{23} - 1$  PRBS with 72 ones and 72 zeros inserted (ITU recommendation G958).

**Pin Definition**

**Pin Out Diagram**

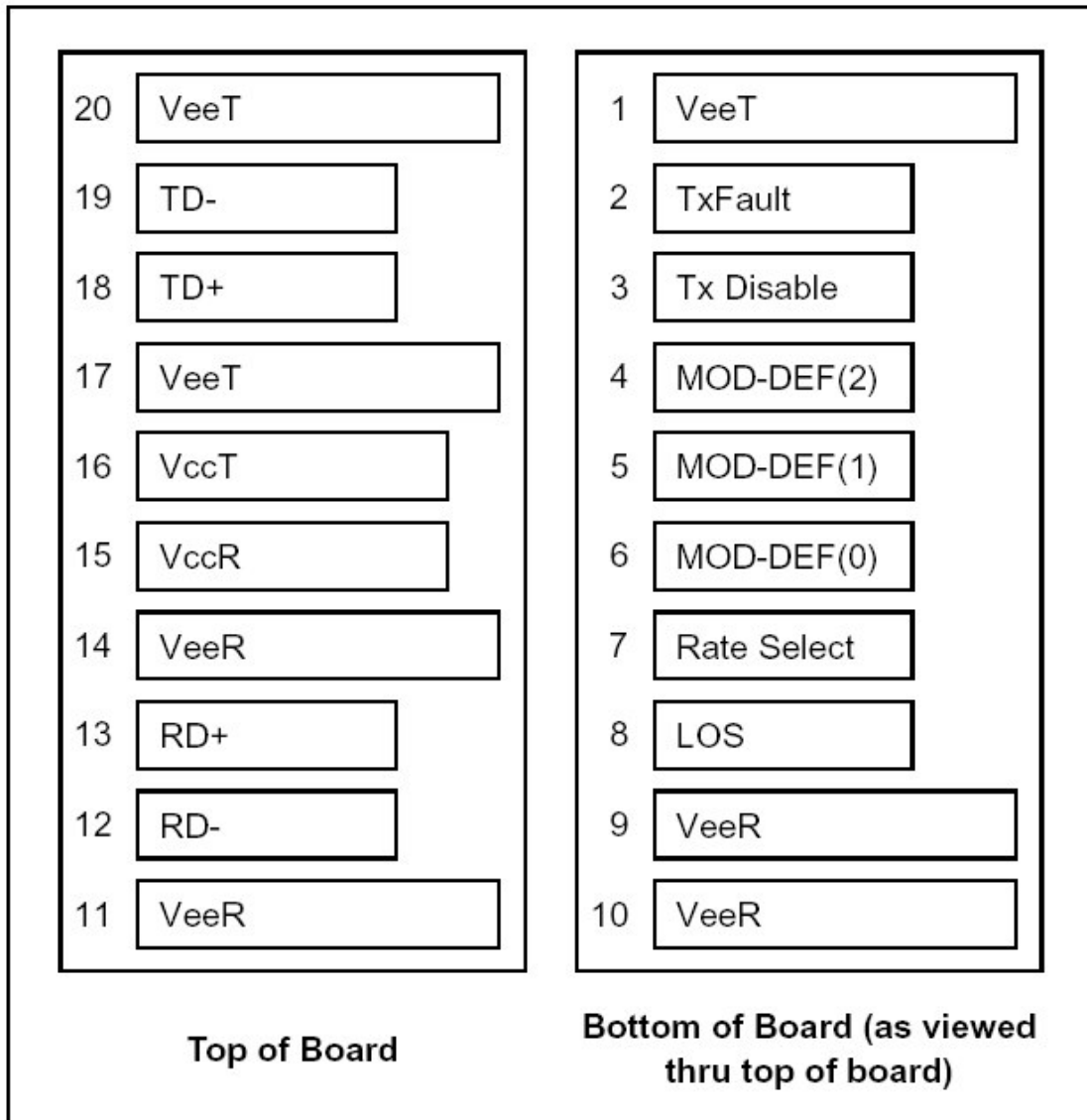

**Table 6.Pin Function Definitions**

Pin#	Name	Description	Notes
1	VeeT	Transmitter Ground	-
2	TX Fault	Transmitter Fault Indication	Notes 1
3	TX Disable	Transmitter Disable	Note 2, Module disables on high or open
4	MOD-DEF2	Module Definition 2	Note3, 2 wire serial ID interface
5	MOD-DEF1	Module Definition 1	Note 3, 2 wire serial ID interface
6	MOD-DEF0	Module Definition 0	Note 3, Grounded in Module
7	Rate Select	Not use	-
8	LOS	Loss of Signal	Note 4
9	VeeR	Receiver Ground	Note 5
10	VeeR	Receiver Ground	Note 5
11	VeeR	Receiver Ground	Note 5
12	RD-	Inv. Received Data Out	Notes 6
13	RD+	Receiver Data out	Notes 6
14	VeeR	Receiver Ground	Note 5
15	VccR	Receiver Power	Note 7, 3.3V $\pm$ 5%
16	VccT	Transmitter Power	Note 7, 3.3V $\pm$ 5%
17	VeeT	Transmitter Ground	Note 5
18	TD+	Transmit Data In	Note 8
19	TD-	Inv. Transmit Data In	Notes 8
20	VeeT	Transmitter Ground	Note 5

**Note:**

- TX Fault is an open collector/drain output, which should be pulled up with a 4.7K–10K $\Omega$  resistor on the host board. Pull up voltage between 2.0V and VccT, R+0.3V. When high, output indicates a laser fault of some kind. Low indicates normal operation. In the low state, the output will be pulled to < 0.8V.**
- TX disable is an input that is used to shut down the transmitter optical output. It is pulled up within the module with a 4.7–10 K $\Omega$  resistor. Its states are:**
  - Low (0 – 0.8V): Transmitter on**
  - (>0.8, < 2.0V): Undefined**
  - High (2.0 – 3.465V): Transmitter Disabled**
  - Open: Transmitter Disabled**
- Mod-Def 0,1,2. These are the module definition pins. They should be pulled up with a 4.7K – 10K $\Omega$  resistor on the host board. The pull-up voltage shall be VccT or VccR. Mod-Def 0 is grounded by the module to indicate that the module is present Mod-Def 1 is the clock line of two wire serial interface for serial ID Mod-Def 2 is the data line of two wire serial interface for serial ID**

4. **LOS (Loss of Signal)** is an open collector/drain output, which should be pulled up with a 4.7K – 10K  $\Omega$  resistor. Pull up voltage between 2.0V and VccT, R+0.3V. When high, this output indicates the received optical power is below the worst-case receiver sensitivity(as defined by the standard in use). Low indicates normal operation. In the low state, the output will be pulled to < 0.8V.
5. **VeeR and VeeT** may be internally connected within the SFP module.
6. **RD-/+**: These are the differential receiver outputs. They are AC coupled 100  $\Omega$  differential lines which should be terminated with 100  $\Omega$  (differential) at the user SERDES. The AC coupling is done inside the module and is thus not required on the host board.
7. **VccR and VccT** are the receiver and transmitter power supplies. They are defined as 3.3V  $\pm$ 5% at the SFP connector pin. Maximum supply current is 300mA. Recommended host board power supply filtering is shown below. Inductors with DC resistance of less than 1  $\Omega$  should be used in order to maintain the required voltage at the SFP input pin with 3.3V supply voltage. When the recommended supply filtering network is used, hotplugging of the SFP transceiver module will result in an inrush current of no more than 30 mA greater than the steady state value. VccR and VccT may be internally connected within the SFP transceiver module.
8. **TD-/+**: These are the differential transmitter inputs. They are AC-coupled, differential lines with 100  $\Omega$  differential termination inside the module. The AC coupling is done inside the module and is thus not required on the host board.

Package information

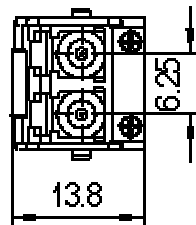
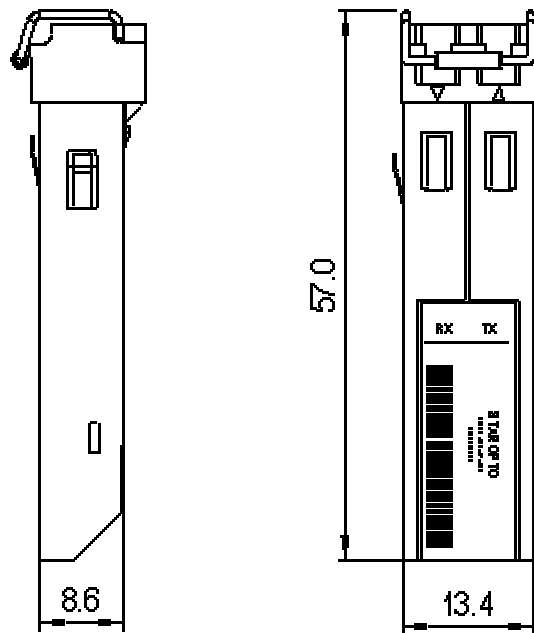



**Recommended Board Layout Hole Pattern**

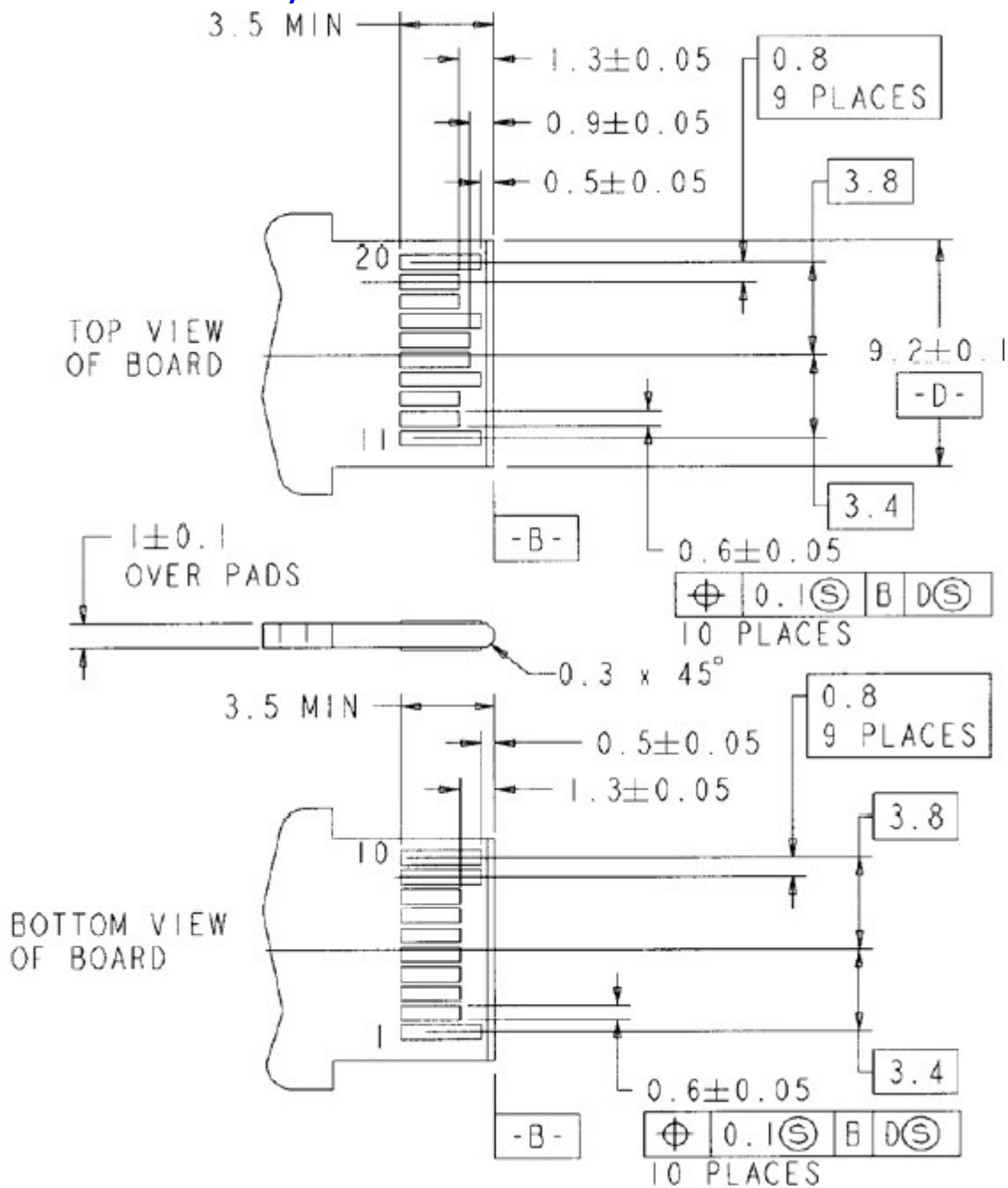

**Obtaining Document**

Please visit our website:

[Http://www.staropto.com](http://www.staropto.com)

**Copyright Star Opto Co., Ltd. 2005**

All Rights Reserved.

All information contained in this document is subject to change without notice. The products described in this document are NOT intended for use in implantation or other life support applications where malfunction may result in injury or death to persons.

The information contained in this document dose not affect or change Star’s product specifications or warranties. Nothing in this document shall operate as an express or implied license or indemnity under the intellectual property rights of Star or third parties. All information contained in this document was obtained in the specific environments, and is presented as an illustration. The results obtained in other operating environment may vary.

THE INFORMATION CONTAINED IN THIS DOCUMENT IS PROVIDED ON AN “AS IS” BASIS. In no event will Star be liable for the damages arising directly from any use of the information contained in this document.

**Ordering Information**

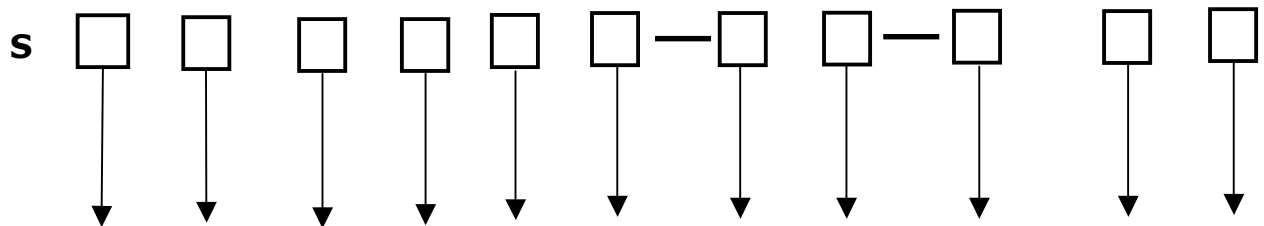

Classification:	Type:	Wavelength:	LD	Data	Package	Output	Power: Operate	Signal	5: LC/PC
S: General	FP	5: 1550nm	Type:	rate :	1: DDM	Power:	3: 3.3V	Detect:	
Product			2: DFB	5:		-3~+2	1: 0~70℃	2: PECL	
				1.25G		(dBm)	2: -40~+85℃	Signal/ TTL	
								Alarm	

Part Number	Product Information
SSFP5251-23-125	SFP 1310nm 1.25Gb/s 0~70℃
SSFP5251-23-225	SFP 1310nm 1.25Gb/s -40~+85℃